

INITIAL EXPERIENCE WITH THE MODIFIED EXTRACORPOREAL LIVER-ASSIST DEVICE FOR PATIENTS WITH FULMINANT HEPATIC FAILURE: SYSTEM MODIFICATIONS AND CLINICAL IMPACT

J. MICHAEL MILLIS,^{1,2,4} DAVID C. CRONIN,² ROBERT JOHNSON,⁴ HARI CONJEEVARAM,³ CAROL CONLIN,⁴ SHARON TREVINO,² AND PATRICK MAGUIRE⁴

Background. The need to find a safe, effective liver support system for patients with fulminant hepatic failure (FHF) continues to be unmet. A system using immortalized human hepatocytes was originally developed in the early 1990s. A modified version of the initial extracorporeal liver-assist device (ELAD) was recently placed into an initial clinical trial at the University of Chicago. The goal of this study was to determine the safety profile of the device at one center before broadening the study to other sites.

Methods. Patients who were diagnosed with FHF and admitted to the University of Chicago were eligible for the ELAD study. Informed consent was obtained, and patients received continuous ELAD therapy until and throughout transplantation. Data were prospectively collected and subsequently analyzed.

Results. Five patients were treated with the device. All patients successfully underwent transplantation. Four of the five patients survived to the 30-day endpoint of the study. There were no biomechanical problems identified. The patients' hemodynamic conditions did not deteriorate during treatment. The adult patients' clinical courses appeared to stabilize while connected to the ELAD (mean arterial pressure range 80–97, mean 88.6; cerebral perfusion pressure range 62–88, mean 76.5). Patient 4 experienced remarkable improvement during ELAD therapy: elimination of phenylephrine, reduction of dopamine from 20 µg/min to 5 µg/min, and reduction of respiratory support from 100% O₂, 10 cm positive end-expiratory pressure to 60% O₂, and 5 cm H₂O positive end-expiratory pressure. The device continued to be metabolically active throughout the study period as documented by oxygen use (mean O₂ change from sampling port before cartridge to sampling port after cartridge for all patients treated = 55 mm Hg).

Conclusions. The patients tolerated treatment with the ELAD well. There were no unanticipated safety issues. The cells in the cartridges were metabolically active. All patients successfully underwent transplan-

tation. The results from this single-institution experience indicates that larger randomized multicenter trials should proceed.

The search for a safe, easily available, reproducible, continuous liver-assist device has been elusive. Although there have been many attempts to support a failing liver, none of the devices have become clinically applicable (1–11). Despite the development of multiple systems of support for other organs, the liver is singular in its inability to be temporarily replaced by an artificial device. To date, none of these systems have proven to be superior to the standard therapy of support followed by liver transplantation. Unfortunately, liver transplantation is not always timely, secondary to organ availability, and has the long-term disadvantage of chronic immunosuppression. Therefore, efforts to provide external liver assistance continue.

The current efforts at external, biologically active liver assistance can be divided into two categories: porcine hepatocytes and immortalized human hepatocytes. Demetriou has extensive experience with a system using porcine cells—the bioartificial liver (1, 2, 6, 8, 11, 16–19). In the early 1990s, Kelly and Sussman developed an extracorporeal liver-assist device (ELAD) using immortalized human hepatocytes (9, 34–37). This device used the C3A hepatocyte cell line in a dialysis cartridge and a blood perfusion system. The initial experience with this device demonstrated system safety, and although the reports described several impressive responses to the system, a multicenter trial did not follow. During the last 3 years, there has been renewed interest in the ELAD that has prompted significant modifications of the original system and the reinitiation of clinical trials. This article documents the changes we developed in the current ELAD system and the initial clinical experience with the new system at a single institution using it to support patients in fulminant hepatic failure (FHF).

MATERIALS AND METHODS

Patients with a diagnosis of FHF admitted to the University of Chicago were eligible for the study. The ELAD device was obtained from VitaGen, Inc., La Jolla, California.

Description of Current ELAD

The patient is connected to the ELAD by a standard dual-lumen hemodialysis catheter inserted in a vein for central access. The ELAD uses ultrafiltrate generated by a 120-kd cutoff ultrafiltrate cartridge. The ultrafiltrate system is heparinized to achieve an activated coagulation time of 200 to 250 sec. Blood is drawn from the patient at a rate of 200 mL/min. The ultrafiltrate is generated at a rate of 20 mL/min. This ultrafiltrate is pumped into an environmen-

This study was sponsored by VitaGen, Inc. The University of Chicago Liver Program is partially funded by the Joan Freeman Memorial Fund.

¹ J.M.M. serves as a consultant and chairman of the medical scientific advisory board of VitaGen, Inc.

² Department of Surgery, University of Chicago, Chicago, IL.

³ Department of Medicine, University of Chicago, Chicago, IL.

⁴ VitaGen, Inc., La Jolla, CA.

Address correspondence to: J. Michael Millis, M.D., Department of Surgery, Section of Transplantation, MC 5027, 5841 S. Maryland Avenue, Chicago, IL 60637.

Received 19 December 2001 Accepted 23 July 02

DOI: 10.1097/01.TP.0000038483.93833.21

1735

tally controlled (temperature 37°C) chamber containing the ELAD cartridges. Each ELAD cartridge contains approximately 100 g of C3A cells within the extracapillary space (ECS) of the hollow fiber cartridges. Four cartridges are used for adult patients, whereas children weighing less than 40 kg receive treatment with two cartridges. The circuit in the environmentally controlled chamber is a high flow rate circuit (flow rate 2 L/min or 500 mL/min per ELAD cartridge). Glucose is added to the circuit in the ELAD chamber to match the glucose consumption rate of the cartridges observed during their production. The ultrafiltrate is passed through the lumen of the fibers in the ELAD cartridges while inside the environmentally controlled chamber. An oxygenator is used in the ELAD circuit to ensure adequate oxygen supply to the cells. Glucose use and oxygen consumption is continuously monitored by sampling ports before and after the ultrafiltrate enters the cartridges to assess metabolic activity of the cells. Two cell filters (0.45 μ m pore size) are placed in the ultrafiltrate return line, which delivers the ultrafiltrate to the blood reentering the patient. The changes in the system and comparisons with the initial device are shown in Table 1 (Safety) and Table 2 (Therapeutic). A diagram of the system is shown in Figure 1. After treatment, the cartridges were shipped back to the manufacturer to determine metabolic activity.

Clinical Protocol

This report documents the first five patients entered into an open-label, randomized, controlled pilot multicenter study of approximately 24 patients with a clinical diagnosis of FHF or primary graft nonfunction. The first five patients were treated at one institution (University of Chicago) and assigned to ELAD treatment to focus on the safety and learning curve of using the device. All patients in this report were candidates for liver transplantation and were evaluated by the University of Chicago Transplant Review Committee.

The clinical decision-making process regarding each patient's progression to transplantation included consultation with the hepatologist, transplant surgeon, and intensivists. When presented with a donor liver for transplantation, concurrence by the surgeon and the hepatologist on the clinical decisions surrounding the patient's orthotopic liver transplantation was required to proceed with or deny liver transplantation independent of study protocol. A schematic overview of the patients treated at the University of Chicago is presented in Figure 2.

Data Safety Monitoring Board

An internal data safety monitoring board monitored patients enrolled in the study during the trial. The members of the data safety monitoring board were one adult hepatologist, one pediatric hepatologist, one adult intensivist, one pediatric intensivist, one liver transplant anesthesiologist, and one liver transplant surgeon. The committee evaluated each patient enrolled in the study in a retrospective manner in regard to historical data and institutional experience. If issues developed during the course of a patient's treatment that could affect the patient in terms of device safety or liver transplantation, the committee would have assembled to discuss the issue(s). Meetings were held within 3 weeks of a patient's enrollment in the study. No additional patients were enrolled in the study until the committee was able to discuss the previous patient's course. The committee was confined to one of three recommendations: (1) continue the study, (2) continue the study after revision, or (3) stop the study. The committee sent a written summary of the meetings to the University of Chicago Institutional Review Board (IRB), VitaGen, Inc. (sponsor), and the U. S. Food and Drug Administration. The principal investigator was allowed to participate in the discussion but was asked to leave before the vote regarding the recommendation. The University of Chicago IRB approved the study.

Biochemical Analyses

Albumin, Transferrin, and Alpha-Fetoprotein Assays. Albumin, transferrin, and alpha-fetoprotein were quantified by standard enzyme-linked immunosorbent assay techniques with the following reagents: anti-human albumin (DiaSorin, Stillwater, MN), transferrin (DiaSorin), or alpha-fetoprotein protein (The Binding Site, San Diego, CA); anti-human albumin peroxidase labeled conjugate (The Binding Site); anti-human transferrin peroxidase labeled conjugate (The Binding Site); and anti-human alpha-fetoprotein peroxidase conjugate (Dako Corporation, Carpinteria, CA).

Galactose Assays

Galactose was assayed by an enzymatic procedure that uses β -galactose dehydrogenase to oxidize D-galactose to D-galactonic acid with the concurrent reduction of NAD⁺ to NADH. The increase in NADH is measured at 224 nm. The procedure was performed as

TABLE 1. Safety enhancements

First generation	Second generation	Clinical benefit
Whole blood through ELAD	Ultrafiltrate of blood through ELADs	Eliminates potential for cartridge clotting experienced in phase I
Produced in pilot plant environment	Fully certified and licensed GMP manufacturing plant	Exemplifies modern controlled manufacturing procedures and eliminates product variability seen in prior phase I
Relied on pressure sensors for cell escape prevention	Adds B. Braun system plus cell escape filters	Virtually eliminates possibility of cell escape

ELAD, extracorporeal liver assist device; GMP, good manufacturing procedure.

TABLE 2. Therapeutic enhancements

First generation	Second generation	Clinical benefit
18–60 g cells	300–400 g cells	Provides 20% of liver mass
Fiber permeability of 70 kd	Fiber permeability of 120 kd	Improves diffusion and contact
Minimal testing and process control	Defined and established testing methodology	Ensures ELADs perform at optimal levels
Infrequent monitoring of cell metabolic activity	Frequent oxygen and glucose consumption monitoring	Ensures cells are metabolically active

ELAD, extracorporeal liver assist device.

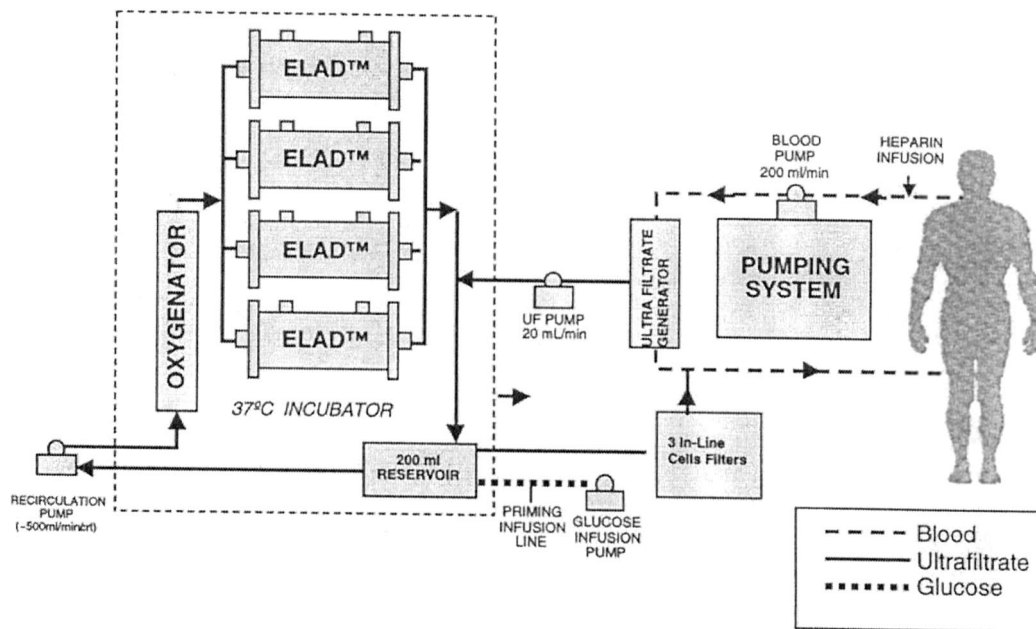

FIGURE 1. Schematic representation of the extracorporeal liver assist device (ELAD) system and patient.

described in the assay kit from Boehringer Mannheim, catalog number 176–303.

Glucose Assays

Glucose concentrations were measured by an enzymatic reaction that uses the oxidation of glucose by glucose oxidase, resulting in the production of gluconic acid and hydrogen peroxide. The hydrogen peroxide reacts in the presence of peroxidase with 4-aminoantipyrine and p-hydroxybenzene sulfonate to form a quinoneimine dye. The plates are then read at 490 nm.

High-Performance Liquid Chromatography Assay for Monoethylglycinexylidide (MEGX)

The MEGX produced by metabolism of lidocaine was assayed as previously described by Chen et al. (38). The extraction procedure was modified from the published procedure in the following manner: Solid phase extraction was performed with 3 mL/200 mg phenyl cartridges (J&W AccuBond, part number 188–0520) that were conditioned with 2 mL methanol followed by 2 mL deionized water. One milliliter of sample containing internal standard was placed on the column that was then washed sequentially with 1 mL water and 1 mL 5% methanol in water followed by 1 mL 5% ethanol in water. The MEGX was then eluted with 1 mL acetonitrile. The acetonitrile was evaporated under a stream of nitrogen and the residue reconstituted in 300 μ L mobile phase of which 100 μ L was injected onto the high-performance liquid chromatography column.

Inclusion Criteria

All patients described in this report were in the category of non-acetaminophen-induced FHF. The inclusion criteria for non-acetaminophen-induced FHF patients were stage II, III, or intravenous (IV) encephalopathy and at least two of the following five criteria: non-A, non-B for drug-induced (non-acetaminophen) FHF, bilirubin greater than 17 mg/dL, jaundice to encephalopathy time more than 7 days, prothrombin time more than 25 sec, age less than 10 years or more than 40 years.

The patients were evaluated for the following characteristics: 30-day survival, complement activation, cytokine release, platelet count, hemorrhage, mean arterial pressure, cerebral perfusion pressure, hemodynamics, arterial ammonia, and Glasgow Coma Score.

RESULTS

Patient 1

S. O. is a 34-year-old woman who was admitted to the University of Chicago with a diagnosis of idiopathic FHF. She was listed with the United Network for Organ Sharing as a status I for liver transplantation. She was in stage III hepatic coma, and laboratory evaluation revealed an international normalized ratio (INR) of 8.3, total bilirubin of 14.9 mg/dL, ammonia of 321 μ g/dL, and serum glutamic pyruvic transaminase of 3,310 IU/L. The coagulation defect was corrected with fresh frozen plasma (FFP), and dialysis catheter and intracranial pressure monitor were placed.

Clinical Course While Receiving ELAD Therapy and After Transplantation. The patient began receiving ELAD therapy, which was continued for 40 hr. While connected to the device, the patient was hemodynamically stable. The patient also maintained stable cerebral perfusion and intracranial pressures. She required no medication to adjust vascular or cerebral pressures during therapy. There were no serious medical occurrences while the patient was connected to the device that would have excluded the patient from further consideration for transplantation. The patient did not require blood or platelet transfusions while connected to the device before transplantation. Data for this patient are grouped with the data for the other adult patients and shown in Figure 3. Urine output and serum creatinine were within normal limits. While on mechanical ventilation, the patient's oxygenation and lung function were stable. A liver from a 60-year-old donor was found, and the patient successfully underwent transplantation. ELAD therapy was terminated at the completion of the transplant. The explanted liver weighed 1,000 g and demonstrated massive centrilobular necrosis. The patient demonstrated an essentially uneventful posttransplant course and was discharged 13 days after transplantation.

Figure 2: ELAD™ Study Treatment Overview

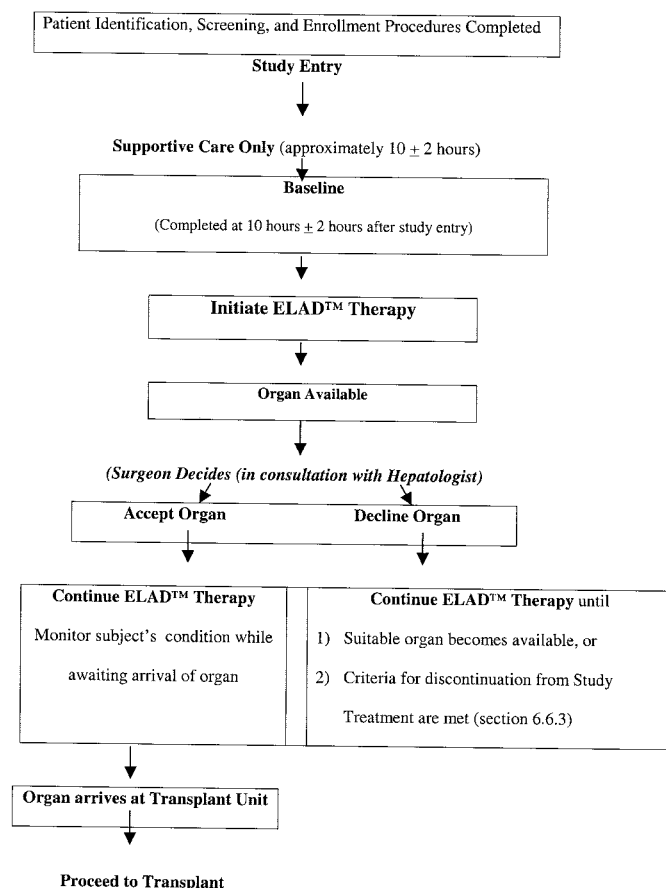

FIGURE 2. Diagram of patient flow through the study design.

Patient 2

C. B. was an 8-year-old white boy in acute liver failure who was transferred from Detroit, Michigan to the University of Chicago Hospital. Liver failure was presumed to be secondary to L-asparaginase hepatic toxicity. He had received this drug to treat his new diagnosis of acute lymphocytic leukemia. Other systemic manifestations of his acute lymphocytic leukemia included a retroperitoneal hematoma and bone marrow infiltration.

His mental status deteriorated to grade III hepatic encephalopathy after transfer to Chicago. Other significant liver metabolic abnormalities were INR 4.43, total bilirubin 23.7 mg/dL, and ammonia 206 mcg/dL. Hematologic indices reflected his leukemia and recent marrow suppression with chemotherapeutic agents: hematocrit 26%, WBC 600, platelet count 64,000.

With deterioration in his clinical condition, and after consultation with oncologists regarding his potential survival with acute lymphocytic leukemia (85% survival), a decision was made to provide liver transplantation and ELAD support. The principal investigator (J. M. M) contacted the sponsor, IRB, and Food and Drug Administration Medical Reviewer, given that this patient fulfilled one exclusion criteria (cancer). Because the patient had been accepted as a trans-

plant candidate, all parties agreed that the patient could be offered ELAD therapy.

Clinical Course While Receiving ELAD Therapy. The patient received ELAD therapy for 80 hr. While connected to the device, the patient's hemodynamic values fluctuated, requiring dopamine at levels slightly higher than renal levels (4 $\mu\text{g}/\text{kg}/\text{min}$). He was placed on the ventilator. Serum creatinine levels remained within normal limits; however, the blood urea nitrogen increased to 31 mg/dL. Because of a noted increase in fluid retention, he was placed without difficulty on continuous venovenous hemofiltration. Data for this patient are shown in Table 3. The patient did require transfusions of red blood cells (4 units), platelets (29 units), and FFP (14 units); however, there was no sign of active hemorrhage. This requirement was believed to be necessary secondary to a lack of production rather than hemorrhage. Device support continued until a pediatric organ became available. The patient underwent transplantation, and ELAD therapy was terminated. The explant weighed 400 g and demonstrated extensive macrovesicular steatosis with central lobular necrosis and dropout. No experimental device-related events affected this child's candidacy for transplantation.

Clinical Course After ELAD Therapy and Liver Transplant. After transplantation, the patient's hemodynamic and metabolic status initially remained stable. However, within 24 hr he became hemodynamically unstable and required norepinephrine. One positive culture from a soft tissue infection revealed gram-negative bacillus. Subsequent to the hemodynamic instability, the patient's neurologic status deteriorated during the next 12 hr (computed tomography scan of the head showed cerebral edema but with no hemorrhage). Pupillary reflexes became absent, and an apnea test was performed. After discussion with the family, the patient was withdrawn from support and expired. No autopsy was performed.

Patient 3

K. S. is a 26-year-old man who was admitted to the University of Chicago hospital with jaundice after a trip out of the country. Elevated liver function tests were noted on admission. Laboratory values were INR 6.03, ammonia 206 $\mu\text{g}/\text{dL}$, bilirubin total 26.3 mg/dL, WBC count 6.02, and platelet count 91K. Hepatitis serologies were negative and there was no history of liver disease. A liver biopsy on the fifth day after admission demonstrated greater than 90% necrosis, and subsequently he quickly progressed to stage III encephalopathy and was placed on the ELAD device. No intracranial pressure monitor was used.

Clinical Course While Receiving ELAD Therapy. Therapy lasted for 18 hr. Mean arterial pressure remained stable. Serum creatinine stayed within normal limits. Summaries of the laboratory values are shown in Figure 3. The patient required 4 units of packed red blood cells (PRBC) during ELAD therapy. There were no occurrences while the patient was connected to the device, which would have excluded him for consideration for transplant. An organ was found, and the patient underwent transplantation. The explant weighed 477 g and demonstrated massive hepatic necrosis.

Clinical Course After ELAD Therapy and Liver Transplant. After transplantation, the patient remained in the intensive care unit for 3 days. He experienced a severe rejection episode that necessitated IV steroids and OKT3, and was

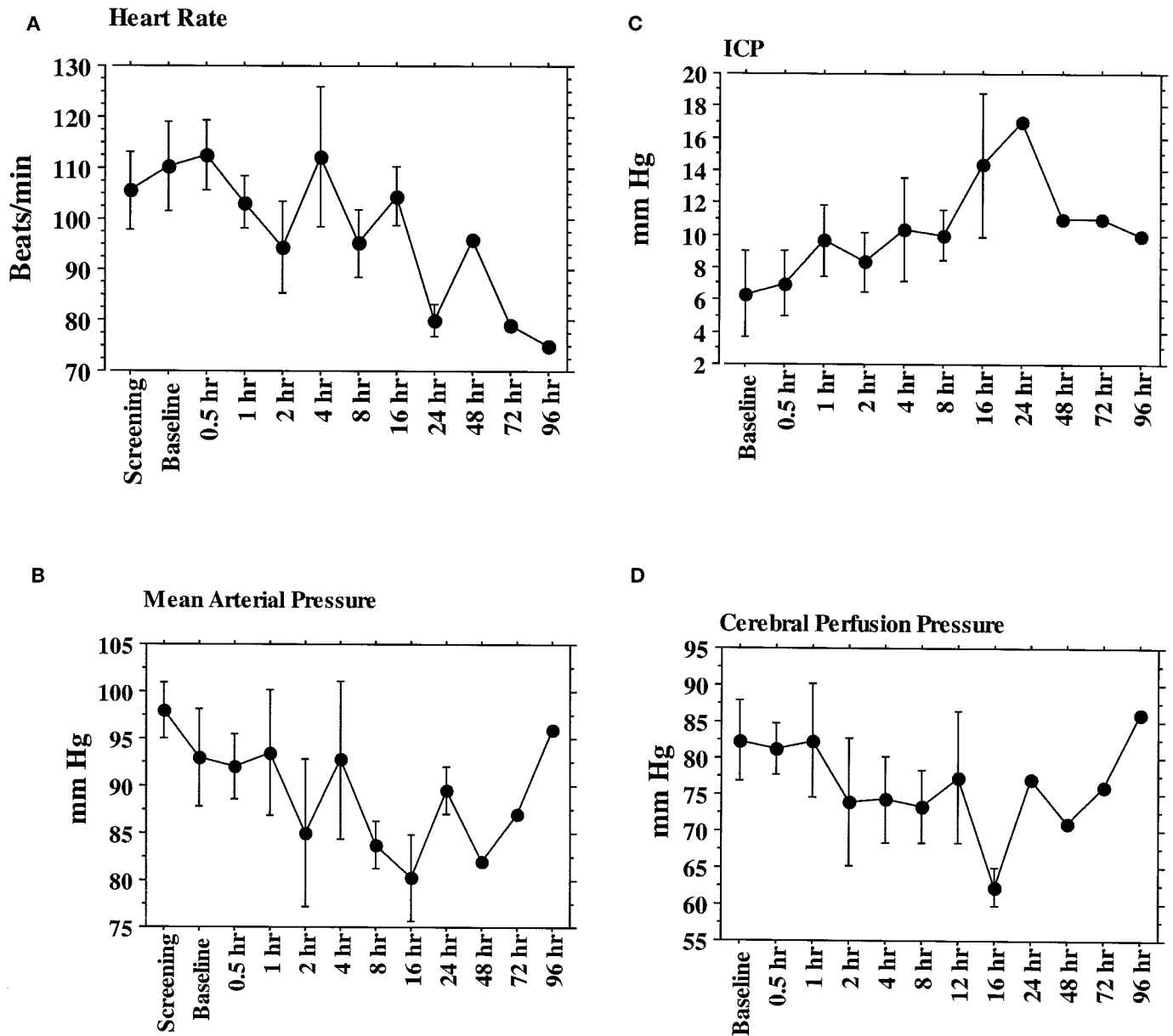

FIGURE 3. Adult patient values of endpoint parameters (all values are presented as mean \pm 1 standard deviation [SD]). (A) Heart rate. (B) Mean arterial pressure. (C) Intracranial pressure (ICP). (D) Cerebral perfusion pressure. (E) Arterial ammonia. (F) Platelet count. (G) Serum creatinine. (H) Serum lactate. (I) Serum pH. (J) Serum factor V level. (K) Serum factor VII. (L) Serum C3a levels. (M) Serum C5a levels. (N) Serum interleukin (IL)-6. (O) Serum tumor necrosis factor (TNF)-alpha.

hemodynamically unstable during this period. He subsequently recovered, was discharged, and is doing well.

Patient 4

A. P. is a 21-year-old white woman who was transferred to the University of Chicago from an area hospital. After a febrile illness, she was diagnosed with idiopathic FHF. She was in stage 2 coma and was intubated at the area hospital. Her INR at the outside hospital was 6.1, and there she was treated with FFP without evidence of hemorrhage. On transfer to the University of Chicago, her mental status deteriorated to stage 4 coma (evaluated after sedation was discontinued). After being listed for orthotopic transplantation, her pulmonary status deteriorated. She required a forced in-

spiratory O_2 (FiO_2) level of 0.6 initially. Before the arrival of the ELAD cartridges, the patient's condition deteriorated manifested by increasing vasopressor (dopamine and dobutamine) and ventilatory (increasing FiO_2 and positive end-expiratory pressure [PEEP]) support.

Clinical Course While Receiving ELAD Therapy and After Transplantation. The deterioration continued for the first 9 hr of ELAD support. She required an FiO_2 of 1.0 and 20 cm PEEP. She required pressor support of 20 μ g/min dopamine and dobutamine and 60 mg/min phenylephrine. Pulmonary artery diastolic pressures were 8 to 12 mm Hg. In the ensuing 40 hr, the patient demonstrated dramatic improvement of her pulmonary and hemodynamic indices. Oxygen requirement dropped to 60%, PEEP to 10 cm H_2O , and dopamine to

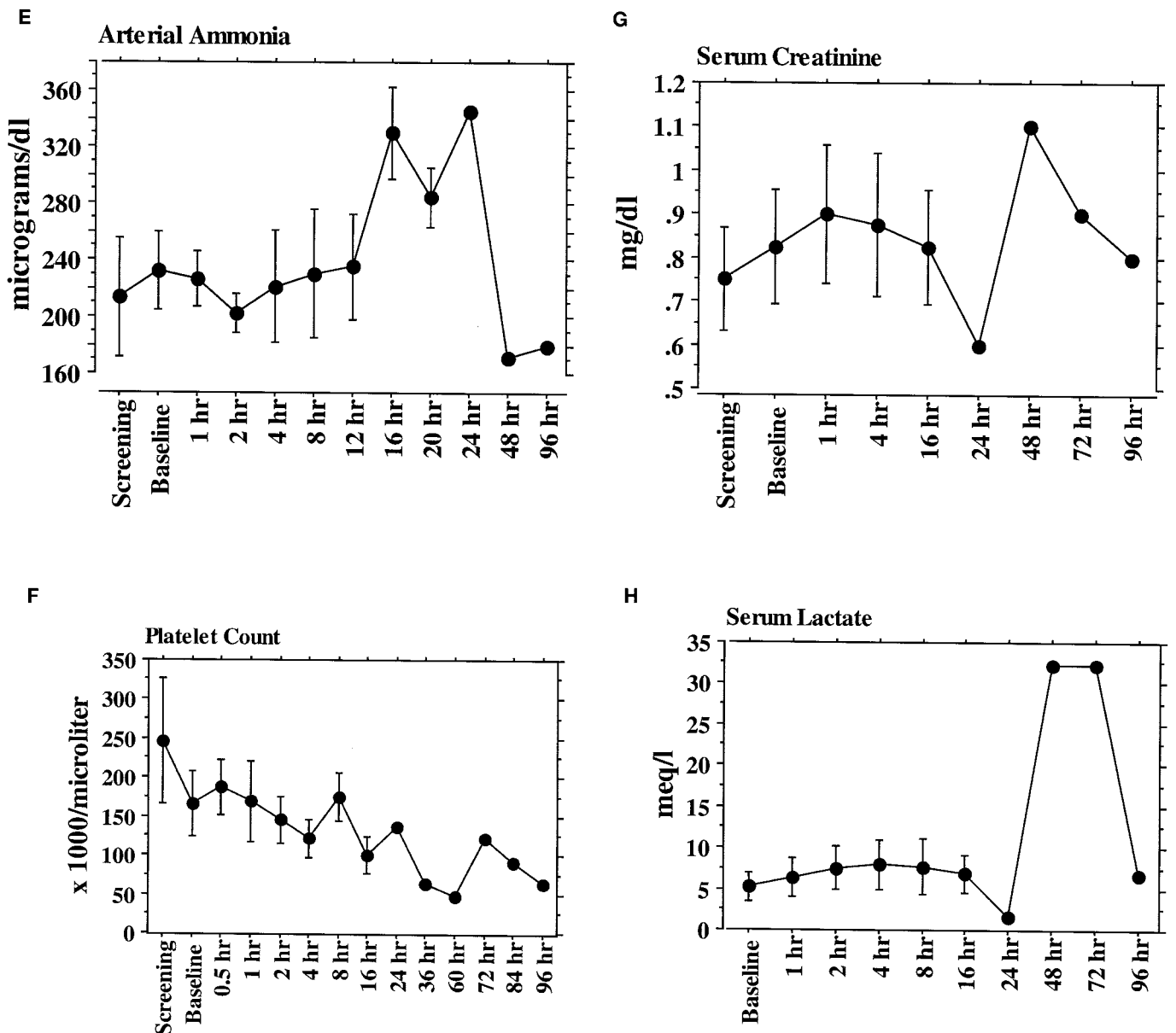

FIGURE 3. Continued

5 $\mu\text{g}/\text{kg}/\text{min}$. All other vasoactive drugs (phenylephrine and dobutamine) were weaned off. Neurologic status remained stable with the intracranial pressure remaining less than 14 mm Hg. Renal function was stable with appropriate urine output and serum creatinine remaining less than 0.8 mg/dL. Ammonia levels decreased from 200 $\mu\text{g}/\text{dL}$ to 95 $\mu\text{g}/\text{dL}$. Details of the laboratory values are shown in Figure 3. An increase in factor V and VII levels was also noted on day 4 (48% to 72% and 16% to 26%, respectively), without a transfusion of FFP. The patient required 2 units PRBCs and 2 units FFP during ELAD therapy. The patient underwent transplantation, and ELAD therapy was terminated after 107 hr of continuous support. The explant weighed 1,200 g and demonstrated bridging centrilobular necrosis and steatosis. Tube thoracostomy was performed because of a pneumothorax at the time of insertion of the double lumen central venous line. Posttransplant, the patient continued to im-

prove. There was no sign of rejection or infection. Neurologic and hemodynamic parameters were within normal limits. The patient did require a temporary tracheostomy and temporary feeding jejunostomy because of vocal chord injury during intubation. She was discharged from the hospital 4 weeks' posttransplant and is doing well.

Patient 5

T. H. is a 22-year-old woman who was admitted to the University of Chicago Hospital in acute hepatic failure. At the time of presentation, her total bilirubin was 15 mg/dL, alkaline phosphatase 222 U/L, SGPT 808 U/L, SGOT 3,243 U/L, albumin 2.2g/dL, and INR 3.0. The patient was treated with FFP and underwent a liver biopsy on the date of admission. The liver biopsy demonstrated 95% hepatic necrosis with evidence of plasma cell infiltration suggestive of autoimmune hepatitis. The patient was treated with IV vitamin

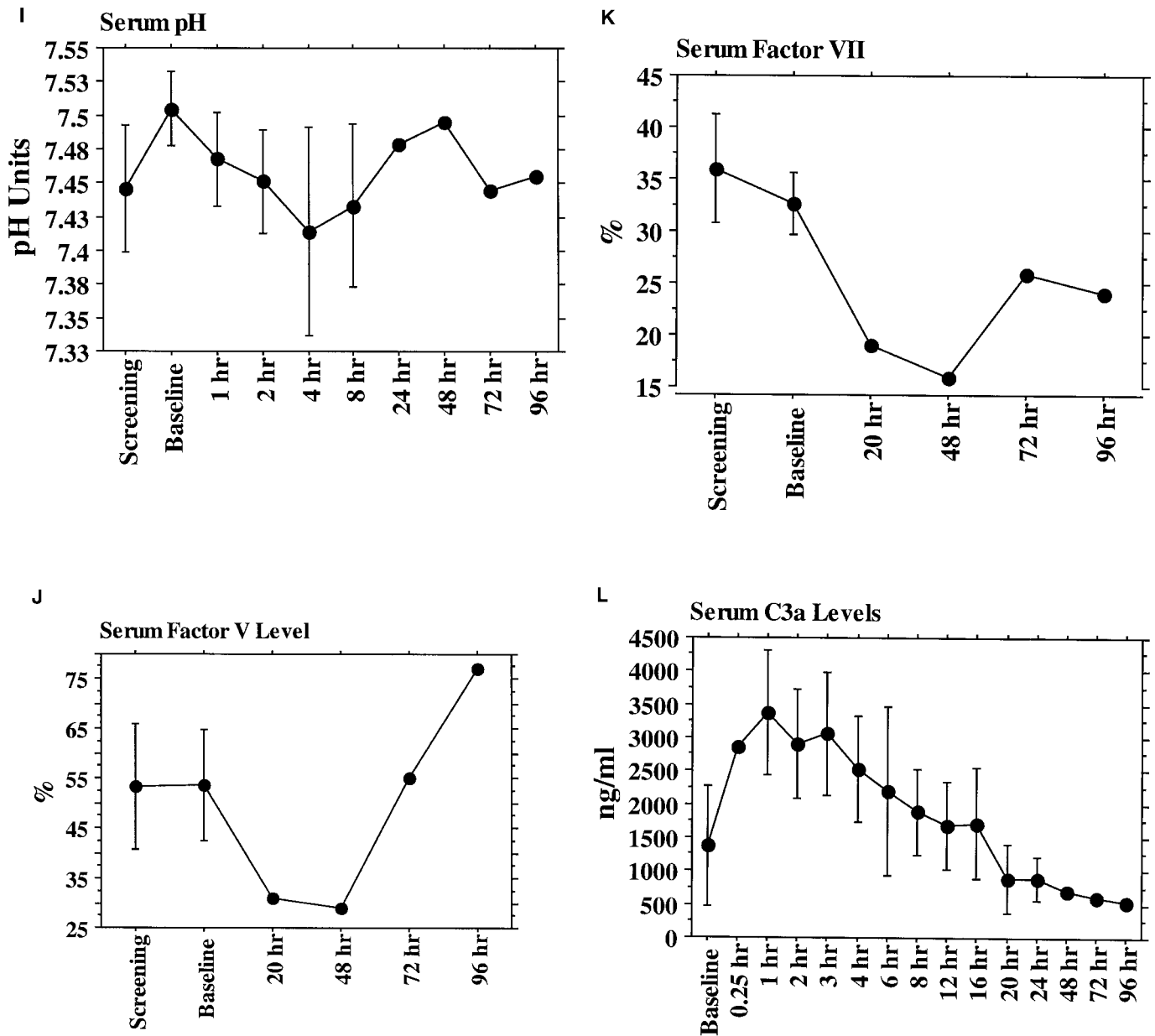

FIGURE 3. Continued

K and high-dose steroid therapy for presumed autoimmune hepatitis. During the next week, the patient's INR peaked at 3.5. Her SGPT and SGOT recovered to 200 U/L and 300 U/L, respectively. Repeat biopsy demonstrated 50% to 60% hepatic necrosis; however, her mental status deteriorated from stage 1 encephalopathy to stage 3 requiring mechanical ventilation and intubation. In addition, her serum ammonia increased to more than 600 $\mu\text{g/dL}$. At this point, she was approved for ELAD therapy (the patient was listed as a liver transplant candidate at the time of presentation, and her status was upgraded to level 1 with the onset of neurologic deterioration).

The patient has a medical history of systemic lupus erythematosus with anticardiolipin antibody, mixed connective tissue disorder, scleroderma, and Raynaud's phenomenon. She has undergone amputation of distal fingertips and joint

irrigation for septic arthritis. She has no history of prior viral hepatitis or biliary disease. Workup for liver transplantation included viral serologies for hepatitis A, B, and C, which were negative. The patient's workup was also negative for Wilson's disease or hemochromatosis. The patient has been managed with low-dose prednisone therapy to control her lupus and mixed connective tissue disorder.

Clinical Course Before and During ELAD Therapy. The patient was maintained on ventilatory support without complication immediately before and during ELAD therapy. In addition, the patient received propofol sedation and was maintained on renal dose dopamine at 3 $\mu\text{g/kg}$. Throughout her hospital stay, including ELAD therapy, her renal function was stable without deterioration. Additional invasive monitoring included intracranial pressure monitor, which was placed immediately after ventilatory support was begun.

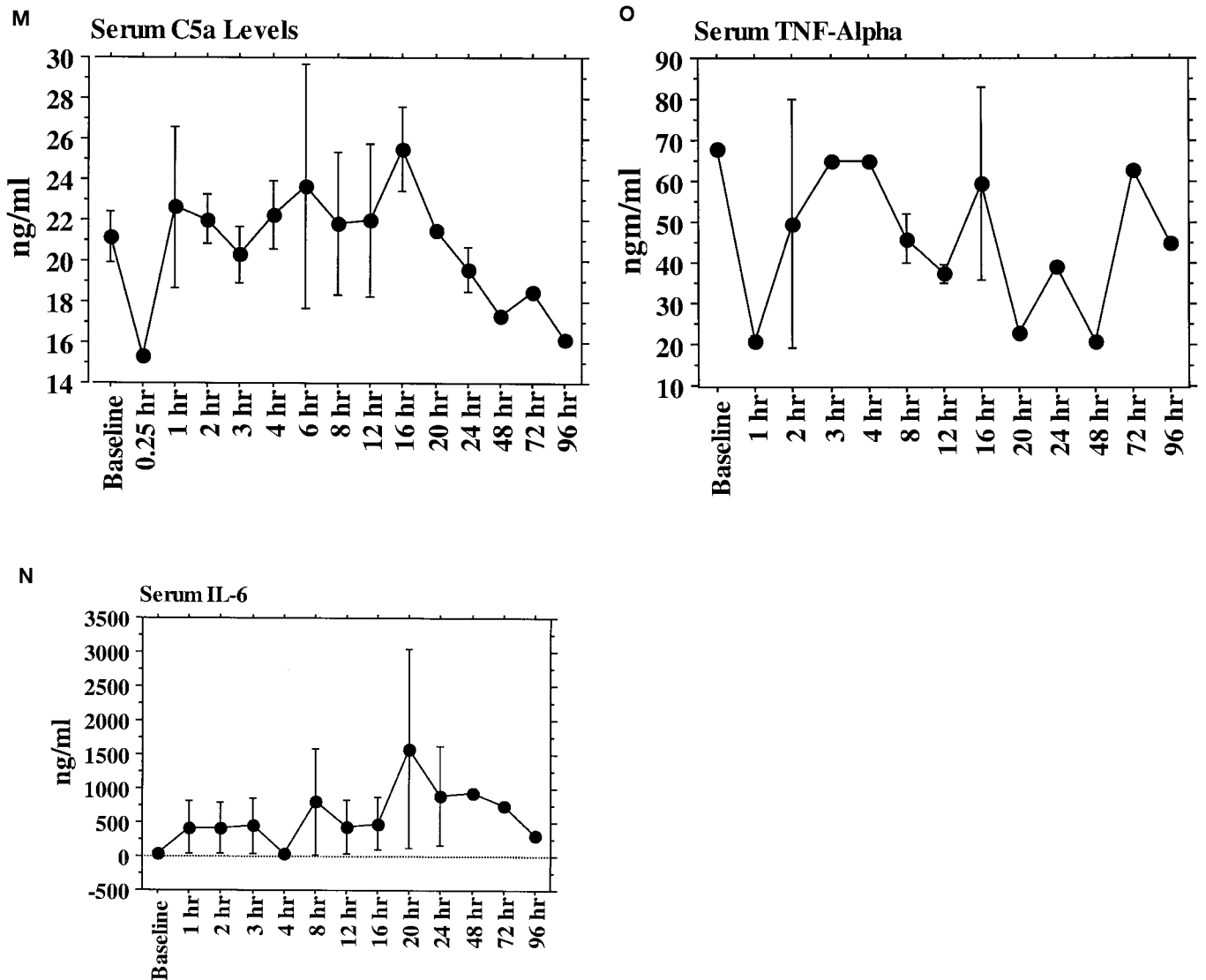

FIGURE 3. Continued

Computed tomographic scan evaluation of the head revealed early cerebral edema. The patient was maintained on ELAD therapy for approximately 12 hr, at which time a liver became available. Details of the laboratory values are shown in Figure 3. The patient did not require any blood products while receiving ELAD therapy. The patient underwent transplantation with an extended right lobe orthotopic liver transplant. The explant weighed 960 g and exhibited bridging hepatic necrosis and dropout.

Clinical Course After ELAD Therapy and Liver Transplant. The patient demonstrated hemodynamic and respiratory stability throughout the operation and postoperative period. She demonstrated immediate graft function on the table with correction of her coagulopathy and slow decrease in her hepatic enzymes in the postoperative period. Her postoperative course is noteworthy for slow emersion from hepatic coma, with postoperative fever approximately 5 days after transplant. It was elected to return the patient to the operating room for abdominal exploration. At the time of surgery, two perforations of the transverse colon were en-

countered and corresponded to the previously identified areas of full thickness scar. Pathologic examination revealed severe acute colitis. A partial colectomy was performed beginning at the terminal ileum and extending to the mid-descending colon. The abdomen was copiously irrigated with physiologic solution. An end ileostomy was performed in the left lower quadrant. The graft was biopsied and demonstrated sharp edges with a good color and quality. The hepatic artery and portal vein were widely patent. She was discharged to the intensive care unit in stable condition. She subsequently recovered and was transferred to a rehabilitation unit for further recovery.

Cartridge Performance During and After Therapy. The five patients reported experienced 257 hr of continuous therapy. All of the ELAD cartridges demonstrated similar performance characteristics and are shown in Figure 4. The ELAD operated continuously and without incident during the 40 hr of therapy. One set of cell filters (patient 1) was changed for a minor elevation in pressure. The ultrafiltrate generator (hollow fiber cartridge) was also changed once (pa-

TABLE 3. Pediatric patient clinical and laboratory values

	Baseline	0.5 hr	1.0 hr	2 hr	4 hr	8 hr	16 hr	24 hr	48 hr	72 hr
Heart rate (beats/min)	166	150	143	142	126	124	114	113	132	119
MAP (mm Hg)	89	116	97	84	69	75	58	56	64	67
Arterial ammonia ($\mu\text{g/dL}$)	411	214	223	219			284		339	452
Platelet count $\times 100/\mu\text{L}$	72		60	55		46	101	69	46	35
Creatinine (mg/dL)	0.5		0.4		0.4		0.5	0.6	0.5	0.7
Lactate (mEq/L)			6.4	7.9	7.4	6.6	7.8	7.4	8.6	19
Serum pH (pH units)			7.56	7.408	7.45	7.39		7.55	7.425	7.323
C3a (ng/mL)			4180	4260	4190	2060	1620		1930	1100
C5a (ng/mL)			27.6	25.2	17.5	17.2	17.6		14.8	43.6
IL-6 (ng/mL)			197.2	219.3	132.6	177.2	223.8	208.9		
TNF-alpha (ng/mL)			22	80	65	52	36	39	21	63
Cartridge performance										
Glucose use (mg/dL)			4	0	4	-3	3	6	-7	
Oxygen use (mm Hg)			74.3	64.9	55.3	56.6	52.4	64.4	103	103
pH change (pH units)			0.093	0.072	0.087	0.034	0.081	0.09	0.11	0.11

MAP, mean arterial pressure; TNF, tumor necrosis factor.

tient 1). This was immediately before transplantation after the heparin had been discontinued in preparation for surgery. At the initiation of therapy for patient 1, the glucose pump was inadvertently turned on, resulting in a high glucose level. This returned to baseline levels. Use levels were consistent with those observed at the time of release from manufacturing. No device malfunction was noted during the course of therapy. After removal, the ELAD cartridges from patients 1 to 3 were maintained in the device and analyzed for alpha feto-protein, glucose, and MEGX production for 6 hr. After 6 hr, the cartridges were flushed with cold (4°C) phosphate buffered saline containing 2.5% human serum albumin and were shipped at 2°C to 8°C back to the manufacturing facility. At the manufacturing facility, the cartridges were tested in a clinical simulation mode for 15 days with culture media in place of the patients' ultrafiltrate. The production of the albumin, transferrin, and alpha feto-protein correlated with the same synthetic rates as at cartridge release to the clinical site. Galactose consumption and MEGX production were similar, as were galactose extraction and glucose use during 12 days of postpatient testing. The function of the cells after the cells were removed from the patients is demonstrated in Table 4.

Summary of Clinical Safety Endpoints and Cartridge Performance

The protocol evaluated seven clinically pertinent safety measures associated with patients in FHF and extracorporeal treatment. The five patients enrolled in the study and reported here demonstrated stable hemodynamics and cerebral perfusion pressure (when monitored), and there was no significant hemorrhage in quantity (>4 units PRBCs) or location (intracranial); only the patient with leukemia required platelet transfusions. None of the patients experienced a clinically significant cytokine or complement activation syndrome. It is important that all patients subsequently underwent transplantation and 4 of 5 patients survived the 30-day endpoint. Two of the patients' explants demonstrated massive necrosis and three explants revealed less extensive necrosis. The difference in necrosis did not seem to affect the patient's course before, during, or after ELAD treatment. The cartridges performed as expected in regard to glucose and oxygen consumption. It was noted that the ammonia levels

within the ELAD recirculating loop were between 200 μM and 600 μM throughout the course of ELAD therapy. Such levels were significantly higher than patient blood concentrations, which generally fell between 100 μM and 200 μM . The ammonia levels within the ELAD system did not appear to affect patient ammonia levels (correlation coefficient = NS).

DISCUSSION

During the past several years, improved understanding of the metabolic functions of the C3A cells, increased concern for patient safety, and the desire to provide as much hepatic support for patients as possible have stimulated a desire to initiate major revisions in the ELAD device. After several years of design planning and animal and bench-top testing, the redesigned system initiated clinical trials in April 1999. The goal of this clinical trial was to ensure patient safety with this newly designed device and protocol. This is the first report describing the changes to the system and the initial clinical trial results.

The current design uses four ELAD cartridges to provide additional C3A cells and, therefore, greater metabolic capacity. The cartridges contain 80 to 100 g of cells in the ECS of each cartridge. The fibers in the current design have a nominal molecular weight cutoff of 120,000 d and a surface area of 1.7 m² per cartridge. The higher molecular weight cutoff membranes were chosen to allow diffusion of albumin across the hollow fiber wall. Albumin produced by the C3A cells could therefore be delivered to the patient, and albumin from the patient carrying bound toxins could diffuse into the C3A cell space to deliver those toxins for clearance.

In the current design, a patient's blood is pumped through an ultrafiltrate generator at a rate of 200 mL/min. The ultrafiltrate generator is a hollow fiber cartridge identical to those used to produce the ELAD cartridges but without cells in the ECS. A separate pump pulls an ultrafiltrate of the blood from the ECS of the ultrafiltrate generator at a rate of 20 mL/min and delivers the ultrafiltrate to the ELAD loop that contains the four active cartridges. The use of ultrafiltrate allows filters to be placed in the circuit to catch any C3A cells, if any escape from the ELAD cartridges, before returning the ultrafiltrate to the patient. See Figure 1 for a schematic of the current version of the ELAD system.

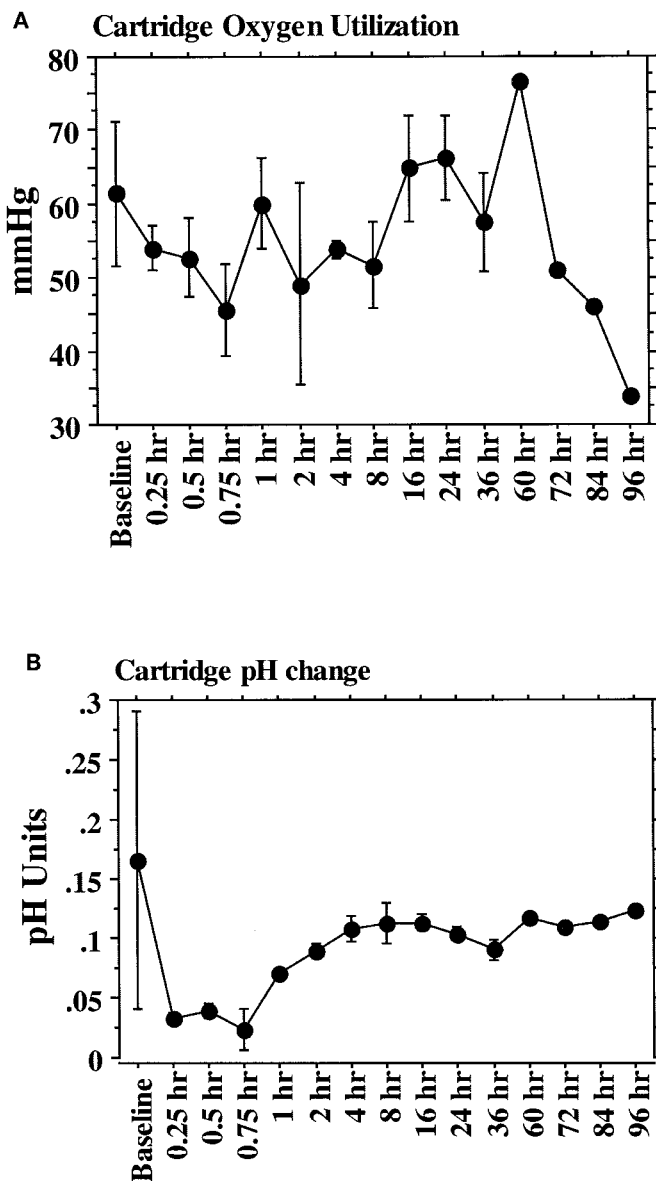

FIGURE 4. Cartridge function during ELAD therapy (all values are presented as mean \pm 1 SD). (A) Oxygen use: Oxygen partial pressure difference (inlet-outlet). (B) pH change: pH unit difference (inlet-outlet).

The current version of the ELAD system also incorporates an oxygenator into the circuit to provide high levels of oxygen to the C3A cells. The pO_2 of the ultrafiltrate entering the ELAD cartridges was measured and compared with the pO_2 of the ultrafiltrate as it exited the cartridges. The system incorporated a glucose infusion pump to provide glucose to the ELAD cartridges during therapy. Taking ultrafiltrate samples before and after exposure to the cells and analyzing the samples for glucose and oxygen consumption accomplished monitoring of metabolic activity.

In the course of monitoring the ultrafiltrate within the ELAD loop during therapy, it was noted that the ammonia levels were usually between 200 μ M and 600 μ M, considerably higher than the 100 μ M to 200 μ M observed in patients' blood. The cause for the high ammonia in the loop may be

secondary to protein deamination in the loop (39). Statistical analysis (correlation coefficient) did not demonstrate a relationship between the loop ammonia and the serum ammonia. There were no adverse events (rising intracranial pressure, hemodynamic instability) noted in this group of patients that could be attributed to the ammonia concentrations in the ELAD loop.

Cartridges were returned to the manufacturer after patient therapy to evaluate function. Table 4 shows the comparison of activity before and after patient therapy. The postpatient testing period was 10 to 15 days.

The clinical safety results are encouraging. All patients successfully underwent transplantation, and 4 of 5 (80%) survived the 30-day endpoint. The device did not produce any significant untoward results. The concerns regarding the initiation of extracorporeal therapy to any patient include complement and cytokine activation related to the tubing and hemorrhage related to the need for heparinization of the extracorporeal system (40–42). These concerns are amplified in the setting of FHF in which endogenous hemostatic mechanisms are deranged. Complement and cytokine activation, as measured by C3a, C5a, tumor necrosis factor, interleukin (IL)-1, IL-2, and IL-6, increased during the time course, but none of the values were outside the upper limits of normal.

There was a modest need for blood products during the study; excluding the patient with leukemia, the need was minimal. There was no life-threatening hemorrhage in any of the patients. All patients underwent cerebral computerized tomography before and after treatment. None of the patients experienced an intracranial hemorrhage. Three of the patients underwent intracranial pressure monitoring, and none of these patients showed evidence of intracranial hemorrhage. The need for blood products in patient 2 was likely a result of hemodilution, laboratory phlebotomy requirements, and lack of production, rather than clinically significant hemorrhage.

The natural history of this cohort of patients is progressive neurologic and hemodynamic deterioration. There was significant concern that these patients would become more hemodynamically unstable with an extracorporeal system. This is frequently seen in critically ill patients undergoing hemodialysis. This was not seen in our cohort of patients. In contrast, our impression from the first three patients was that the hemodynamic status of the patients stabilized during treatment. This impression was confirmed in our experience with patient 4, whose hemodynamic condition improved dramatically while receiving therapy. This improvement enabled her successful transplant. None of the patients who were treated at the University of Chicago demonstrated significant hemodynamic or neurologic deterioration during ELAD therapy. It should also be noted that none of the patients experienced any significant neurologic improvement during the study period. It is difficult to speculate whether the ELAD would decrease intracranial hypertension, because the three patients who underwent intracranial pressure monitoring did not have intracranial hypertension.

Patients with FHF are known to be susceptible to infections. Broad-spectrum cephalosporin antibiotic coverage was prescribed for all patients. This possibility is even greater with the placement of central lines and a continuous extracorporeal system. Tapping into the ultrafiltrate to assess oxygen and glucose use invasively monitors the system.

TABLE 4. Cartridge performance

	Albumin production (mg/day/ELAD)	Transferrin production (mg/day/ELAD)	AFP (mg/day/ELAD)	Glucose consumption (g/day/ELAD)	Galactose consumption (μ mol/min/ELAD)	MEGX production (μ mol/hr/ELAD)
Patient 1 release ^a	241.8 \pm 57.1	93.7 \pm 28.4	43.9 \pm 11.3	16.7	24.6	0.55 \pm 0.1
Patient 1 U of C ^b	ND	ND	43.5	14.1	ND	0.22
Patient 1 manufacturing ^c	248.4 \pm 71.9	118.9 \pm 28.8	36.6 \pm 9.1	ND	25.2 \pm 1.9	0.56
Patient 2 release ^a	275.2 \pm 65.6	120.4 \pm 30.5	50.7 \pm 13.7	17.6	24.6	0.55 \pm 0.1
Patient 2 U of C ^b	ND	ND	73.2	18.6	25.4	0.58
Patient 2 manufacturing ^c	197.3 \pm 52.8	111.1 \pm 38.1	56.3 \pm 19.3	19.7 \pm 1.8	31.2 \pm 1.9	0.8 \pm 0.9
Patient 3 release ^a	204.6 \pm 18.8	140.7 \pm 23.7	36.3 \pm 5.0	20.5	24.6	0.55 \pm 0.1
Patient 3 U of C ^b	ND	ND	9.58	17.9	5.4	0.61
Patient 3 manufacturing ^c	263.2 \pm 44.9	125.1 \pm 26.3	43.8 \pm 11.5	17.7 \pm 1.9	33.6 \pm 2.6	0.35 \pm 0.22
Patient 4 release ^a	219.3 \pm 33.7	87.3 \pm 13.2	49.6 \pm 16.3	14 \pm 1.0	24.6	0.55 \pm 0.1
Patient 4 manufacturing ^c	177.2 \pm 21.5	66.7 \pm 11.0	31.2 \pm 10.8	14.4 \pm 3.6	24.4 \pm 4.3	0.25 \pm 0.7
Patient 5 release ^a	211.0 \pm 62.8	63.3 \pm 14.8	55.7 \pm 5.7	13.3 \pm 1.5	24.6	0.55 \pm 0.1
Patient 5 manufacturing ^c	160.2 \pm 26.0	139.5 \pm 77.5	34.9 \pm 6.7	13.8 \pm 1.9	34.1 \pm 0.4	0.36 \pm 0.2

^a At release from manufacturing facility before use on patient.

^b At the University of Chicago, immediately after removal from patient.

^c After the cartridges have been flushed, cooled, and shipped back to VitaGen after use on patient.

ELAD, extracorporeal liver assist device; MEGX, monoethylglycineylidide; ND, not determined; AFP, alpha-fetoproteins.

These invasive maneuvers increase the opportunity to introduce infection. None of the patients treated at the University of Chicago experienced a significant infection during or immediately after ELAD treatment. Patient 5 experienced several infections after her transplant; however, these infections are believed to be secondary to her underlying autoimmune syndromes and vasculitis (12, 13, 14, 15, 20, 21, 22, 23, 24, 25, 26, 27, 28, 29, 30, 31, 32, 33).

Although we are encouraged by the results of these five patients in regard to safety, we must caution that the number of patients treated with this new device in this report is small. FHF is a complex disease, and many more patients will need to be treated to ascertain the full safety profile and provide an insight into the potential therapeutic efficacy of this device.

REFERENCES

1. Arkadopoulos N, Detry O, Rozga J, et al. Liver assist systems: State of the art. *Int J Artif Organs* 1998; 21(12): 781.
2. Detry O, Arkadopoulos N, Ting P, et al. Clinical use of a bioartificial liver in the treatment of acetaminophen-induced fulminant hepatic failure. *Am Surg* 1999; 65(10): 934.
3. Ellis AJ, Hughes RD, Wendon JA, et al. Pilot-controlled trial of the extracorporeal liver assist device in acute liver failure. *Hepatology* 1996; 24(6): 1446.
4. Fremont B, Joly A, Desille M, et al. Cell-based therapy of acute liver failure: The extracorporeal bioartificial liver. *Cell Biol Toxicol* 1996; 12(4-6): 325.
5. Hughes RD, Williams R. Use of bioartificial and artificial liver support devices. *Semin Liver Dis* 1996; 16(4): 435.
6. Hui T, Rozga J, Demetriou AA. Bioartificial liver support. *J Hepatobiliary Pancreat Surg* 2001; 8(1): 1.
7. Jauregui HO, Muller TE. Long-term cultures of adult mammalian hepatocytes in hollow fibers as the cellular component of extracorporeal (hybrid) liver assist devices. *Artif Organs* 1992; 16(2): 209.
8. Kamohara Y, Rozga J, Demetriou AA. Artificial liver: Review and Cedars-Sinai experience. *J Hepatobiliary Pancreat Surg* 1998; 5(3): 273.
9. Kelly JH, Sussman NL. The hepatic extracorporeal liver assist device in the treatment of fulminant hepatic failure. *ASAIO J* 1994; 40(1): 83.
10. Sussman NL, Gislason GT, Conlin CA, et al. The hepatic extracorporeal liver assist device: Initial clinical experience. *Artif Organs* 1994; 18(5): 390.
11. Ting PP, Demetriou AA. Clinical experience with artificial liver support systems. *Can J Gastroenterol* 2000; 14(suppl D): 79D.
12. Williams R. Classification, etiology, and considerations of outcome in acute liver failure. *Semin Liver Dis* 1996; 16(4): 343.
13. Naik S, Trenkler D, Santangini H, et al. Isolation and culture of porcine hepatocytes for artificial liver support. *Cell Transplant* 1996; 5(1): 107.
14. Adams RM, Wang M, Crane AM, et al. Effective cryopreservation and long-term storage of primary human hepatocytes with recovery of viability, differentiation, and replicative potential. *Cell Transplant* 1995; 4(6): 579.
15. Darr TB, Hubel A. Postthaw viability of precultured hepatocytes. *Cryobiology* 2001; 42(1): 11.
16. Khalili TM, Navarro A, Ting P, et al. Bioartificial liver treatment prolongs survival and lowers intracranial pressure in pigs with fulminant hepatic failure. *Artif Organs* 2001; 25(7): 566.
17. Kamohara Y, Sugiyama N, Mizuguchi T, et al. Inhibition of signal transducer and activator transcription factor 3 in rats with acute hepatic failure. *Biochem Biophys Res Commun* 2000; 273(1): 129.
18. Lilja H, Kamohara Y, Neuman T, et al. Transforming growth factor beta1 helps maintain differentiated functions in mitogen-treated primary rat hepatocyte cultures. *Mol Cell Biol Res Commun* 1999; 1(3): 188.
19. Watanabe FD, Arnaout WS, Ting P, et al. Artificial liver. *Transplant Proc* 1999; 31(1-2): 371.
20. Baquerizo A, Mhoyan A, Kearns-Jonker M, et al. Characterization of human xenoreactive antibodies in liver failure patients exposed to pig hepatocytes after bioartificial liver treatment: An ex vivo model of pig to human xenotransplantation. *Transplantation* 1999; 67(1): 5.
21. Mang R, Maas J, Chen X, et al. Identification of a novel type C porcine endogenous retrovirus: Evidence that copy number of endogenous retroviruses increases during host inbreeding. *J Gen Virol* 2001; 82(Pt 8): 1829.
22. Quinn G, Langford G. The porcine endogenous retrovirus long terminal repeat contains a single nucleotide polymorphism that confers distinct differences in estrogen receptor binding affinity between PERV A and PERV B/C subtypes. *Virology* 2001; 286(1): 83.
23. Specke V, Rubant S, Denner J. Productive infection of human primary cells and cell lines with porcine endogenous retroviruses. *Virology* 2001; 285(2): 177.
24. Jin H, Inoshima Y, Wu D, et al. Expression of porcine endogenous retrovirus in peripheral blood leukocytes from ten different breeds. *Transpl Infect Dis* 2000; 2(1): 11.
25. Switzer WM, Michler RE, Shanmugam V, et al. Lack of cross-species transmission of porcine endogenous retrovirus infection to nonhuman primate recipients of porcine cells, tissues, or organs. *Transplantation* 2001; 71(7): 959.
26. Tacke SJ, Bodusch K, Berg A, et al. Sensitive and specific immunological detection methods for porcine endogenous retroviruses applicable to experimental and clinical xenotransplantation. *Xenotransplantation* 2001; 8(2): 125.
27. Takefman DM, Wong S, Maudru T, et al. Detection and characterization of porcine endogenous retrovirus in porcine plasma and porcine factor VIII. *J Virol* 2001; 75(10): 4551.
28. Loss M, Arends H, Winkler M, et al. Analysis of potential porcine endog-

- enous retrovirus (PERV) transmission in a whole-organ xenotransplantation model without interfering microchimerism. *Transpl Int* 2001; 14(1): 31.
29. Herring C, Cunningham DA, Whittam AJ, et al. Monitoring xenotransplant recipients for infection by PERV. *Clin Biochem* 2001; 34(1): 23.
 30. Patience C, Switzer WM, Takeuchi Y, et al. Multiple groups of novel retroviral genomes in pigs and related species. *J Virol* 2001; 75(6): 2771.
 31. Elliott RB, Escobar L, Garkavenko O, et al. No evidence of infection with porcine endogenous retrovirus in recipients of encapsulated porcine islet xenografts. *Cell Transplant* 2000; 9(6): 895.
 32. Heneine W, Switzer WM, Soucie JM, et al. Evidence of porcine endogenous retroviruses in porcine factor VIII and evaluation of transmission to recipients with hemophilia. *J Infect Dis* 2001; 183(4): 648.
 33. Czauderna F, Fischer N, Boller K, et al. Establishment and characterization of molecular clones of porcine endogenous retroviruses replicating on human cells. *J Virol* 2000; 74(9): 4028.
 34. Kelly JH, Koussayer T, He D, et al. Assessment of an extracorporeal liver assist device in anhepatic dogs. *Artif Organs* 1992; 16(4): 418.
 35. Sussman NL, Chong MG, Koussayer T, et al. Reversal of fulminant hepatic failure using an extracorporeal liver assist device. *Hepatology* 1992; 16(1): 60.
 36. Sussman NL, Kelly JH. Liver assist devices (LADs) will not be used to treat fulminant hepatic failure (FHF), but its consequences, namely hepatic encephalopathy (HE). *Artif Organs* 1993; 17(1): 43.
 37. Sussman NL, Kelly JH. Extracorporeal liver assist in the treatment of fulminant hepatic failure. *Blood Purif* 1993; 11(3): 170.
 38. Chen Y, Potter JM, Ravenscroft PJ. A quick, sensitive high-performance liquid chromatography assay for monoethylglycinexylidide and lignocaine in serum/plasma using solid-phase extraction. *Ther Drug Monit* 1992; 14(4): 317.
 39. Prytz B, Grossi CE, Rousselot LM. In vitro formation of ammonia in blood of dog and man. *Clin Chem* 1970; 16(4): 277.
 40. Schlee H, Prondzinsky R, Osten B, et al. [Systemic inflammatory reactions to extracorporeal therapy measures (I): Hemodialysis and hemofiltration]. *Wien Klin Wochenschr* 1997; 109(9): 301.
 41. Inoue H, Saito I, Nakazawa R, et al. Expression of inflammatory cytokines and adhesion molecules in haemodialysis-associated amyloidosis. *Nephrol Dial Transplant* 1995; 10(11): 2077.
 42. Shaldon S, Dinarello CA. The relationship between biocompatibility and interleukin-1. *Life Support Syst* 1987; 5(4): 341.

0041-1337/02/7412-1746/0

TRANSPLANTATION

Copyright © 2002 by Lippincott Williams & Wilkins, Inc.

Vol. 74, 1746-1751, No. 12, December 27, 2002

Printed in U.S.A.

LOW RECURRENCE RATE OF HEPATOCELLULAR CARCINOMA AFTER LIVER TRANSPLANTATION: BETTER PATIENT SELECTION OR LOWER IMMUNOSUPPRESSION?

MARCO VIVARELLI,^{1,4} ROBERTO BELLUSCI,¹ ALESSANDRO CUCCHETTI,¹ GIULIA CAVRINI,² NICOLA DE RUVO,¹ ARDO ABDIUELI ADEN,¹ GIULIANO LA BARBA,¹ STEFANO BRILLANTI,³ AND ANTONINO CAVALLARI¹

Background. Liver transplantation is currently offered to a limited number of patients with hepatocellular carcinoma (HCC) because of strict criteria introduced in the past to avoid recurrence. Immunosuppression represents a risk factor for tumor growth; the schedules of the immunosuppressant drugs have been modified through the years, aiming to reduce their dosage to the effective minimum.

Methods. A series of 106 consecutive patients with HCC who underwent transplantation over a 15-year period at a single institution was retrospectively reviewed to ascertain whether tumor recurrence was influenced by the Milano criteria presently adopted in patient selection and whether the dosage of immuno-

suppressant agents administered was associated with tumor recurrence. Fifteen patients who died postoperatively and 9 with a follow-up of less than 1 year were excluded; presence of the Milano criteria, tumor-node-metastasis staging, and the cumulative dosage of the single immunosuppressants given at different intervals in the first postoperative year were analyzed in the remaining 82 patients. The influence of these variables on overall and recurrence-free survival was assessed statistically.

Results. The Milano criteria did not influence recurrence-free survival, which was instead associated with the cumulative dosage of cyclosporine administered in the first postoperative year (93% 5-year recurrence-free survival for patients given low dosage vs. 76% for those given high dosage; $P=0.01$); T3 and T4 tumors did worse than T1 and T2 tumors.

Conclusions. Current limits to transplantation for HCC might be reassessed in view of modified patient management; immunosuppression should be minimized in these patients.

Hepatocellular carcinoma is frequently observed in patients with chronic liver disease; these patients often have a poor hepatic functional reserve that does not allow liver resection (1, 2). Orthotopic liver transplantation can offer a cure to both the chronic liver disease and the hepatocellular carcinoma (3, 4).

¹ Department of Surgery and Transplantation, University of Bologna, Bologna, Italy.

² Department of Statistical Sciences, University of Bologna, Bologna, Italy.

³ Department of Internal Medicine and Gastroenterology, University of Bologna, Bologna, Italy.

⁴ Address correspondence to: Marco Vivarelli, M.D., Dipartimento di Discipline Chirurgiche, Rianimatorie e dei Trapianti, Chirurgia II, Policlinico S.Orsola, Via Massarenti, 9, 40138 Bologna, Italy. E-mail: vivarelli@orsola-malpighi.med.unibo.it.

Received 12 March 2002. Revision requested 14 May 2002. Accepted 20 August 2002.

DOI: 10.1097/01.TP.0000039170.17434.33